

# Pylon

## NL Reclamezuilen: Pyloon systemen

### Specificaties

<b>Sign systeem:</b>	Pyloon, informatiezuil, totems
<b>Kenmerken:</b>	Profielen voor miniframes tot XL formaat
<b>Medium:</b>	Reclameplaat, ACP plaat
<b>Verlichting:</b>	LED
<b>Uitvoering:</b>	Met en zonder versterkte binnenprofiel
<b>Types:</b>	80-ST, 80-V, 80/2V, 80/1V, 80-VFF, 50-R, 20-S, 20/2S, H, LLF
<b>Profiel:</b>	6100 mm, EN AW 6060 T6, brute
<b>Op aanvraag:</b>	Voetplaat, gewalste panelen, gelaste binnenframe en als bouw pakket
<b>Compleet op voorraad:</b>	Nee, wel op maat te bestellen
<b>Extra:</b>	Horizontaal als verticaal te gebruiken

## EN Advertising pillars: Pylon systems

### Specifications

<b>Sign system:</b>	Pylon, information pillar, totems
<b>Features:</b>	Profiles for miniframes till XL format
<b>Medium:</b>	Advertisements & ACP sheets
<b>Light source:</b>	LED
<b>Use:</b>	Indoor & outdoor
<b>Types:</b>	80-ST, 80-V, 80/2V, 80/1V, 80-VFF, 50-R, 20-S, 20/2S, H, LLF
<b>Profil:</b>	6100 mm, mill, anodised or lacquered
<b>Upon request</b>	Footbase, rolled panels, welded inner frame and as a DIY kit
<b>Standards:</b>	No, but made to order service available
<b>Extra:</b>	Can be used horizontally as well as vertically

## DE Werbepylone Spezifikationen

<b>Sign System:</b>	Pylon
<b>Eigenschaften:</b>	Profil und Zubehör für Pylone, Infosäulen oder Totem
<b>Medium:</b>	Aluminiumplatten, Acrylplatten oder Aluminium-Verbundplatten (ACP)
<b>Beleuchtung:</b>	LED
<b>Anwendung:</b>	Mit oder ohne Innenkonstruktion
<b>Typ:</b>	80-ST, 80-V, 80/2V, 80/1V, 80-VFF, 50-R, 20-S, 20/2S, H, LLF
<b>Auf Anfrage:</b>	Fußplatten, gewalzte Pylon-Tafeln, geschweißte Innenrahmen und als Bausatz lieferbar
<b>Profil:</b>	6100 mm EN AW 6060 T6, erhältlich in roh
<b>Anmerkung:</b>	Kann sowohl horizontal als auch vertikal eingesetzt werden



# Pylon

## XL Pylon



### 80-V

- Vierkant binnen koker
  - Eén geheel profiel
  - Geïntegreerde klemdetail
  - Max. plaatdikte 5 mm
- Square inner tube
  - One complete profile
  - Integrated clamping system
  - Max. panel thickness 5 mm
- Eckiges Innenrohr
  - Ein Komplettes Profil
  - Integrierte Klemmdetails
  - Max. Blechdicke 5 mm



### 80/2V

- Vierkant binnen koker
  - Gebruik van klemlijst en afdichtrubber t.b.v. plaatwissel
  - Zijdetailering voor contourverlichting
  - Max. plaatdikte 5 mm
- Square inner tube
  - Use of retainer and sealrubber for sheet change
  - Side details for illumination
  - Max. panel thickness 5 mm
- Eckiges Innenrohr
  - Nutzung der Klemmleiste und Gummi-Dichtung für das wechseln der Platte
  - Seitendetails zur Beleuchtung
  - Max. Blechdicke 5 mm



### 80-VFF

- Vierkant binnen koker
  - FastFix detail t.b.v. verstevigingsprofiel
  - Vernieuwde geïntegreerde klemdetail
  - Max. plaatdikte 6 mm
- Square inner tube
  - FastFix detail for reinforcement profile
  - Renewed integrated clamping detail
  - Max. panel thickness 6 mm
- Eckiges Innenrohr
  - FastFix detail für Verstärkungsprofil
  - Erneute integrierte Klemmdetails
  - Max. Blechdicke 6 mm

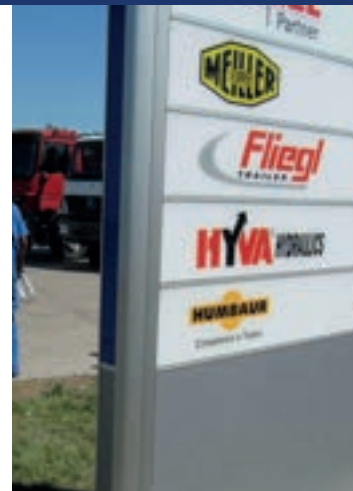

### 80/1V

- Verschillende formaten binnen koker mogelijk
  - Gebruik van klemlijst en afdichtrubber t.b.v.plaatwissel
  - Zijdetailering voor verlichting
  - Max. plaatdikte 5 mm
- Different size inner tube possible
  - Use of retainer and sealrubber for sheet change
  - Side details for illumination
  - Max. panel thickness 5 mm
- Verschiedenen maßen Innenrohr Möglich
  - Nutzung der Klemmleiste und Gummi-Dichtung für das wechseln der Platte
  - Seitendetails zur Beleuchtung
  - Max. Blechdicke 5 mm

## 80-V

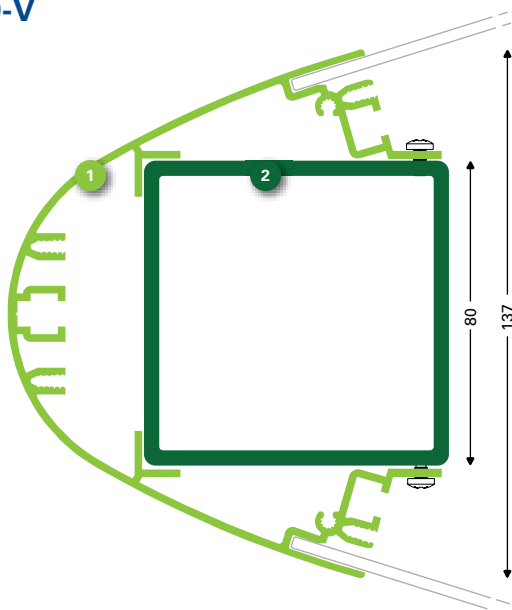

- 133110 (133112\*)**  
Pylon Profiel 80-V brute  
Pylon Profile 80-V mill  
Pylon Profil 80-V roh
- 107232, 6 m**  
Rechthoekige koker 80x80x4.0 brute  
Rectangular tube 80x80x4.0 mill  
Rechteckrohr 80x80x4.0 roh



## 80-VFF

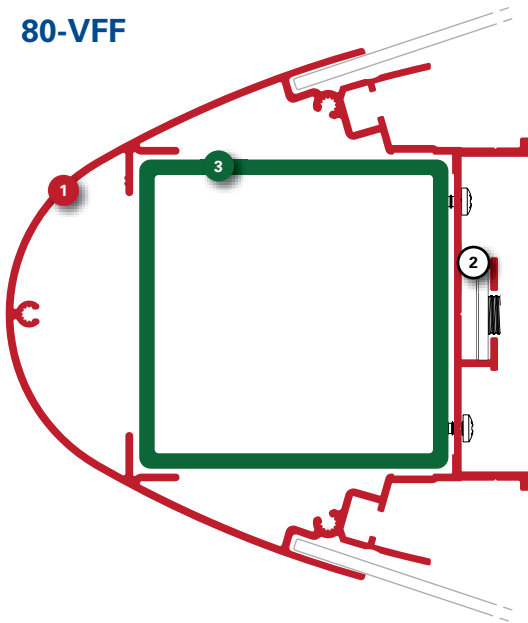

- 1 133123 (133124\*)**  
Pylon Profiel 80-VFF brute  
Pylon Profile 80-VFF mill  
Pylon Profil 80-VFF roh
- 2 130378**  
Hamerkopbout M10x20-T-NX RVS  
Hammerheadscrew M10x20-T-NX stainless steel  
Hammerkopfbolz M10x20-T-NX INOX
- 3 107232, 6 m**  
Rechthoekige koker 80x80x4.0 brute  
Rectangular tube 80x80x4.0 mill  
Rechteckrohr 80x80x4.0 roh



## 80/1V

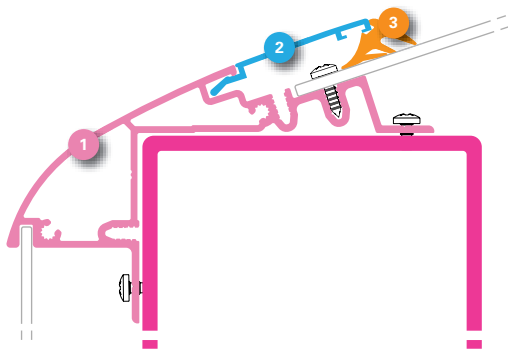

- 1 133138 (133139\*)**  
Pylon 80/1V brute  
Pylon 80/1V mill  
Pylon 80/1V roh
- 2 133130 (133132\*)**  
Pylon Klemlijst 80/1 & 2V brute  
Pylon Retainer 80/1 & 2V mill  
Pylon Klemmleiste 80/1 & 2V roh
- 3 133129**  
Afdichtings rubber rubber L [2 mm]  
Seal rubber L [2 mm]  
Gummi-Dichtung L [2 mm]
- 133128**  
Afdichtings rubber S [4 mm]  
Seal rubber S [4 mm]  
Gummi-Dichtung S [4 mm]



## 80/2V

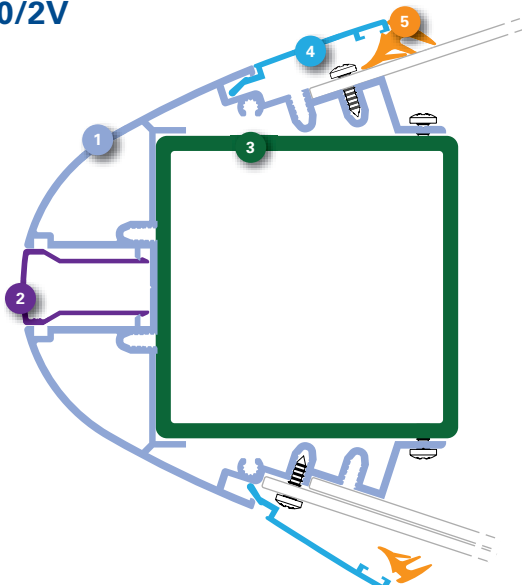

- 1 133125 (133127\*)**  
Pylon Profiel 80/2V brute  
Pylon Profile 80/2V mill  
Pylon Profil 80/2V roh
- 2 133030 (133032\*)**  
Klikprofiel brute  
Click profile mill  
Schnappleiste roh
- 3 107232, 6 m**  
Rechthoekige koker 80x80x4.0 brute  
Rectangular tube 80x80x4.0 mill  
Rechteckrohr 80x80x4.0 roh
- 4 133130 (133132\*)**  
Pylon Klemlijst 80/2V brute  
Pylon Retainer 80/2V mill  
Pylon Klemmleiste 80/2V roh
- 5 133128, 150 m**  
Afdichtingsrubber rubber S [4mm]  
Seal rubber S [4mm]  
Gummi-Dichtung S [4mm]
- 133129, 100 m**  
Afdichtingsrubber rubber L [2mm]  
Seal rubber L [2mm]  
Gummi-Dichtung L [2mm]

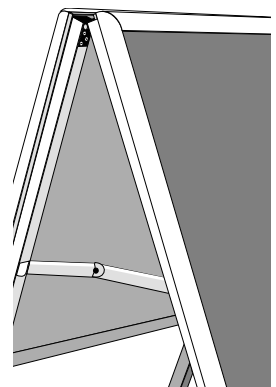

\* Geanodiseerd profiel / anodised profile / eloxiert Profil

# Pylon

## 80/1V

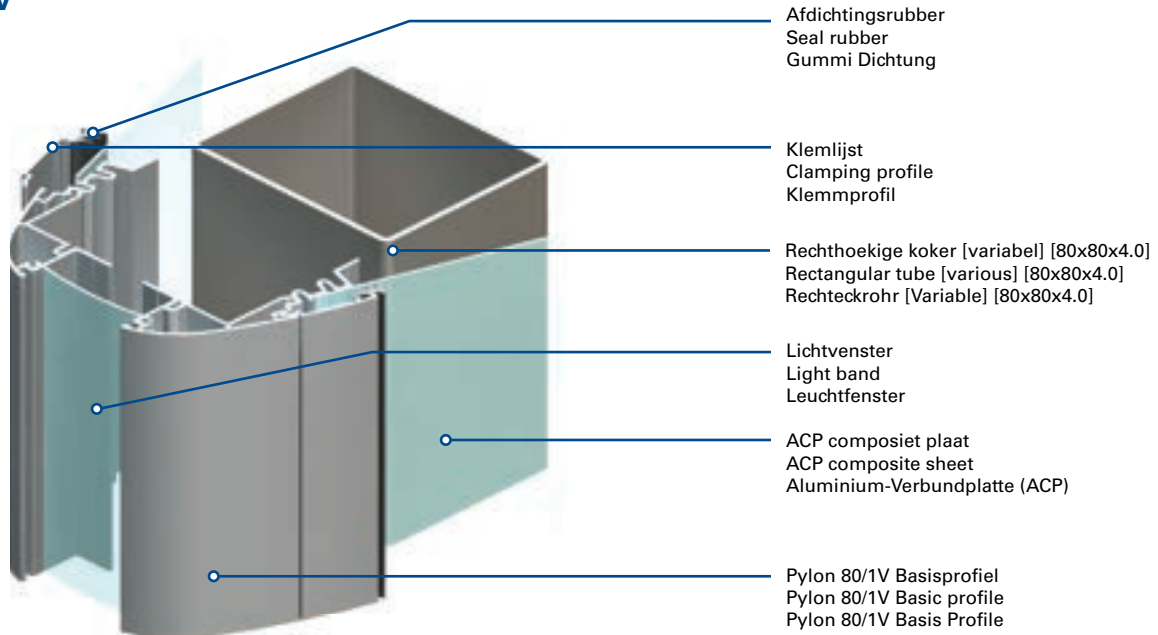

## 80/2V

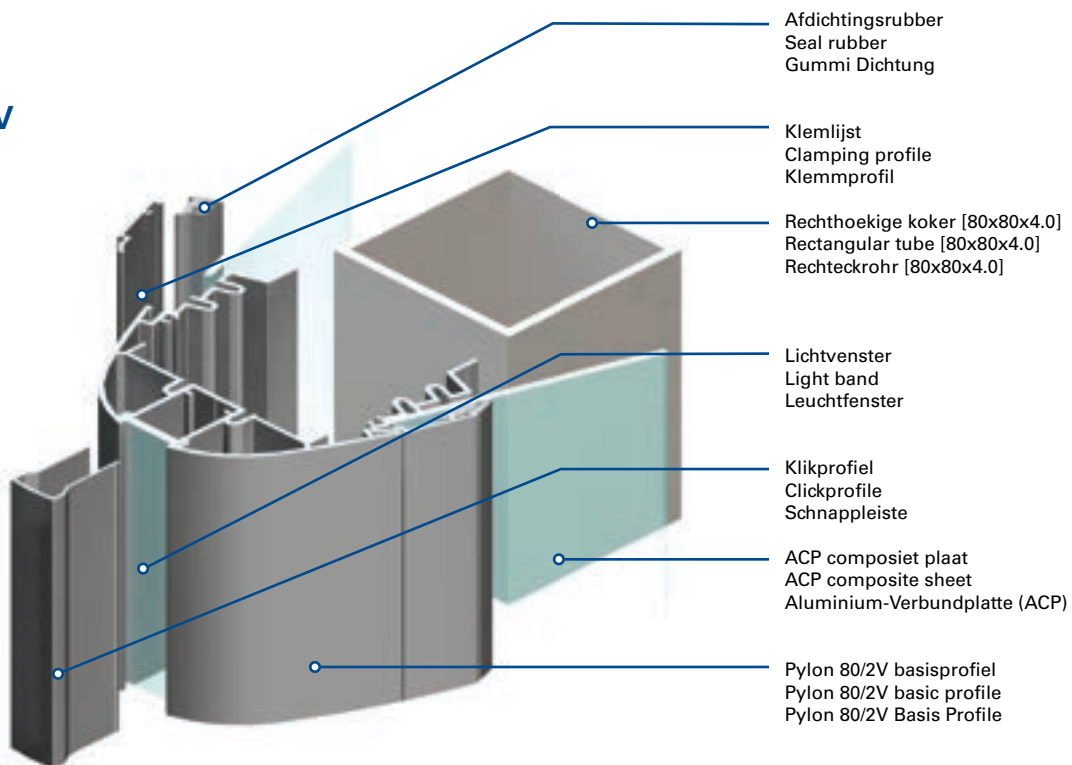

## 50-R Pylon voorbeelden/ examples/ Beispiele

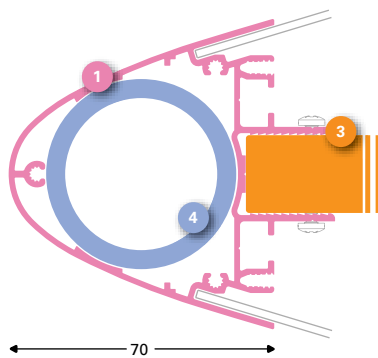
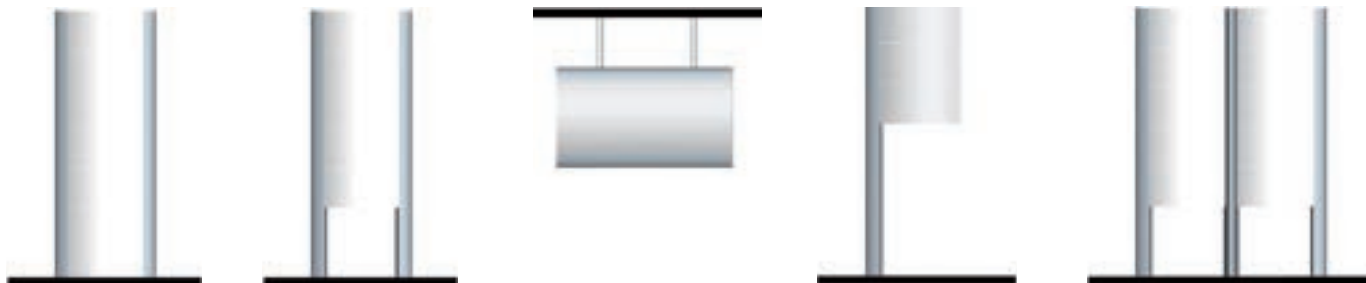

**1 133115 (133117\*)**  
 Pylon Profiel 50-R brute  
 Pylon Profile 50-R mill  
 Pylon Profil 50-R roh

**2 133120 (133122\*)**  
 Pylon Afdekprofiel 50-R brute  
 Pylon Cover profile 50-R mill  
 Pylon Abdeckprofil 50-R roh

**3 107050**  
 Rechthoekige koker 30x20x2.0 brute  
 Rectangular tube 30x20x2.0 mill  
 Rechteckrohr 30x20x2.0 roh

**107090**  
 Rechthoekige koker 40x20x2.0 brute  
 Rectangular tube 40x20x2.0 mill  
 Rechteckrohr 40x20x2.0 roh

**4 106110**  
 Ronde buis 50x40 brute  
 Round tube 50x40 mill  
 Rundröhre 50x40 roh

**5 Pylon 50-R in combinatie met ACP (composiet plaat 4,0 mm)**  
 Pylon 50-R in combination with ACP (composit sheet 4.0 mm)  
 Pylon 50-R kombiniert mit (ACP Verbundplatte 4,0 mm)

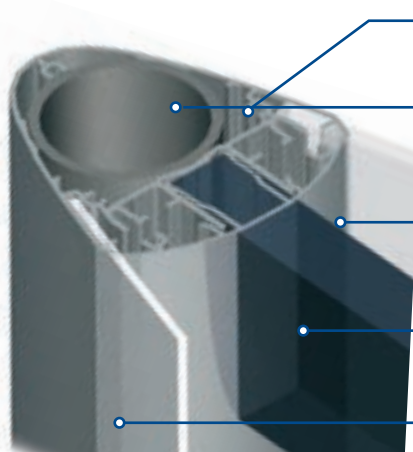
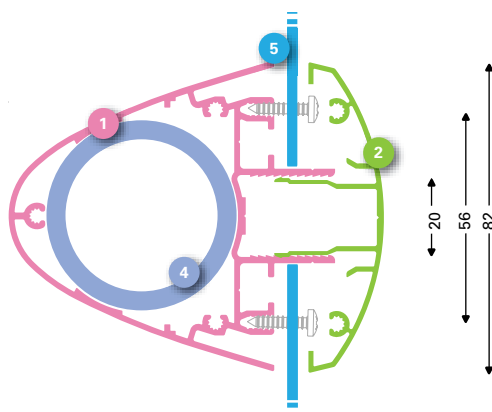
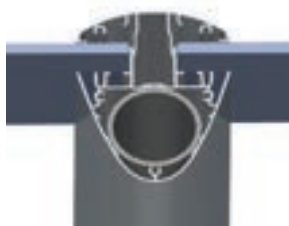

Pylon 50-R profiel  
 Pylon 50-R profile  
 Pylon 50-R Profil

Ronde buis 50x40  
 Round tube 50x40  
 Rundröhre 50x40

Afdekprofiel 50-R  
 Cover profile 50-R  
 Abdeckprofil 50-R

Bord  
 Panel  
 Schild

ACP composiet plaat 3 mm  
 ACP composite sheet 3 mm  
 Aluminium-Verbundplatte (ACP) 3 mm

\* Geanodiseerd profiel / anodised profile / eloxiert Profil

H-verbinder/ H-connector/ H-Verbinder

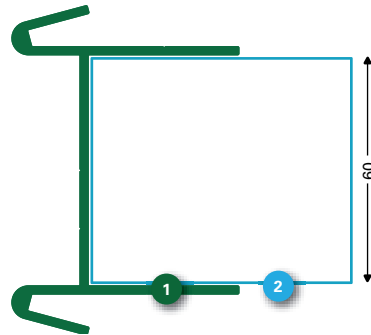

- 1 133105 (133107\*)**  
Pylon H brute  
Pylon H mill  
Pylon H roh
- 2 107205**  
Rechthoekige koker 60x60x4.0 brute  
Rectangular tube 60x60x4.0 mill  
Rechteckrohr 60x60x4.0 roh

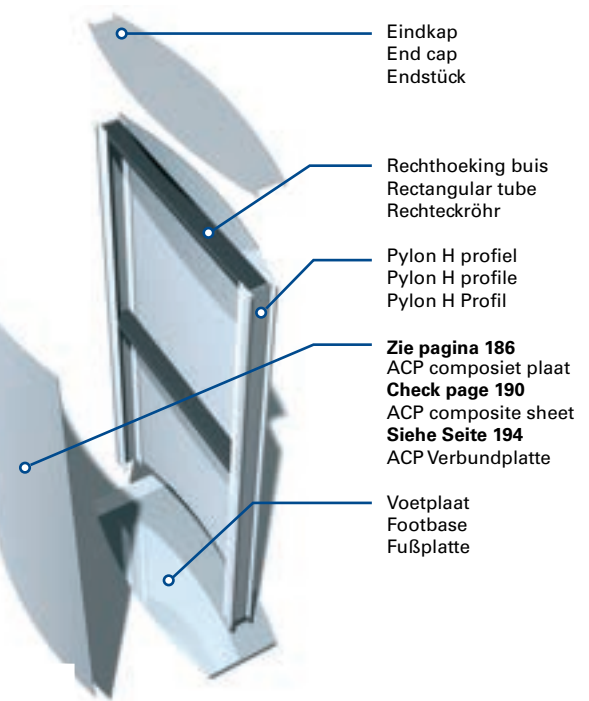

Eindkap  
End cap  
Endstück

Rechthoeking buis  
Rectangular tube  
Rechteckrohr

Pylon H profiel  
Pylon H profile  
Pylon H Profil

**Zie pagina 186**  
ACP composiet plaat  
**Check page 190**  
ACP composite sheet  
**Siehe Seite 194**  
ACP Verbundplatte

Voetplaat  
Footbase  
Fußplatte

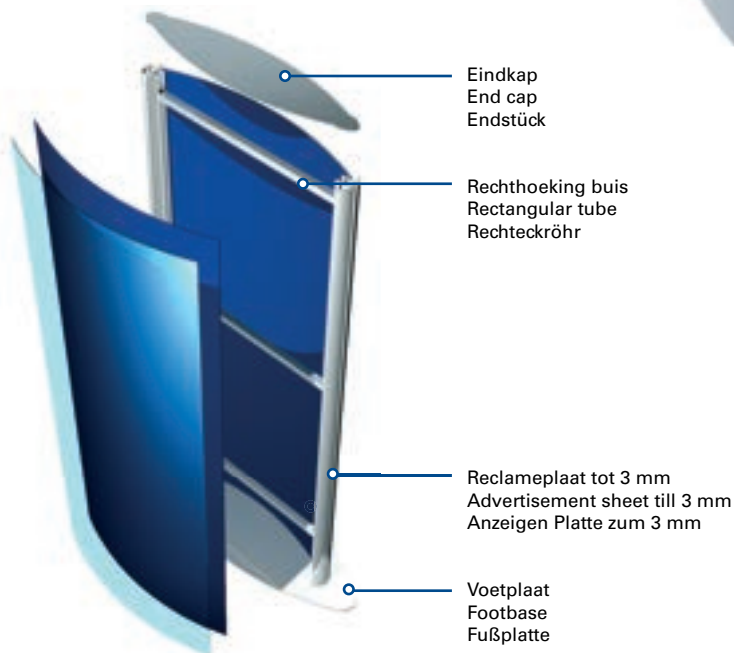

Eindkap  
End cap  
Endstück

Rechthoeking buis  
Rectangular tube  
Rechteckrohr

Reclameplaat tot 3 mm  
Advertisement sheet till 3 mm  
Anzeigen Platte zum 3 mm

Voetplaat  
Footbase  
Fußplatte

# Pylon

## Pylon LLF

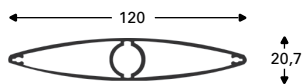

**133150, 6,1 m**  
 Pylon/Lamel 120 brute  
 Pylon/Aerofoil 120 mill  
 Pylon/Lamelle 120 roh

**133152**  
 Pylon/Lamel afdekkap 120 brute  
 Pylon/Blade cover 120 mill  
 Pylon/Lamelle Abdeck 120 roh

**133151, 6,1 m**  
 Pyloon - Lamel 120 Houtlook  
 Pylon/Aerofoil 120 Wood look  
 Pylon/Lamelle 120 Holzoptik

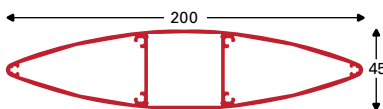

**133140, 6,1 m**  
 Pylon/Lamel 200 brute  
 Pylon/Aerofoil 200 mill  
 Pylon/Lamelle 200 roh

**133145**  
 Pylon/Lamel afdekkap 200 brute  
 Pylon/Blade cover 200 mill  
 Pylon/Lamelle Abdeck 200 roh

**107120**  
 Rechthoekige koker 40x40x4.0 brute  
 Rectangular tube 40x40x4.0 mill  
 Rechteckrohr 40x40x4.0 roh

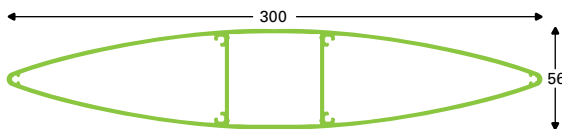

**133160, 6,1 m**  
 Pylon/Lamel 300 brute  
 Pylon/Blade 300 mill  
 Pylon/Lamelle 300 roh

**133167**  
 Pylon/Lamel afdekkap 300 brute  
 Pylon/Blade cover 300 mill  
 Pylon/Lamelle Abdeck 300 roh

**107172**  
 Rechthoekige koker 50x50x4.0 brute  
 Rectangular tube 50x50x4.0 mill  
 Rechteckrohr 50x50x4.0 roh

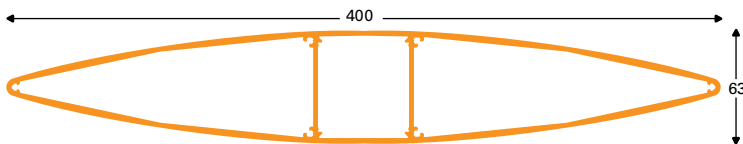

**133180, 4 m**  
 Pylon/Lamel 400 4000 brute  
 Pylon/Blade 400 4000 mill  
 Pylon/Lamelle 400 4000 roh

**133185**  
 Pylon/Lamel afdekkap 400 brute  
 Pylon/Blade cover 400 mill  
 Pylon/Lamelle Abdeck 400 roh

**107172**  
 Rechthoekige koker 50x50x4.0 brute  
 Rectangular tube 50x50x4.0 mill  
 Rechteckrohr 50x50x4.0 roh

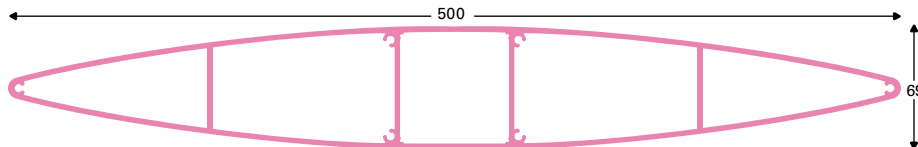

**133200, 4 m**  
 Pylon/Lamel 500 4000 brute  
 Pylon/Blade 500 4000 mill  
 Pylon/Lamelle 500 4000 roh

**133205**  
 Pylon/Lamel afdekkap 500 brute  
 Pylon/Blade cover 500 mill  
 Pylon/Lamelle Abdeck 500 roh

**107205**  
 Rechthoekige koker 60x60x4.0 brute  
 Rectangular tube 60x60x4.0 mill  
 Rechteckrohr 60x60x4.0 roh

